

Project: _____
 Fixture Type: _____ Quantity: _____
 Customer: _____

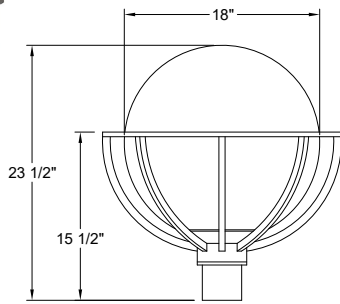

Specifications

Material:
 Fitter is durable 356 cast aluminum.
 All hardware provided shall be stainless steel or zinc plated steel.

Globe:
 Impact-resistant Polycarbonate.

Mounting:
 Mounts natively to Ø3" pole or tenon. Consult factory for other options.

Drivers:
 Universal Voltage 120-277V is standard. 0-10V, TRIAC & ELV (1%) dimming is standard. (Refer to Driver Specification section for other specifications)

Electrical:
 Approximately 12" of pull wire extends from luminaire. All luminaires are prewired with 0-10V dimming leads. Line Voltage leads are 14ga, dimming leads are 18ga.

Finish:
 A polyester powder coat high quality finish. Marine grade finish is available.

Certifications:
 UL Listed for outdoor, wet location. LED and Driver are IP66.

Modifications:
 Consult factory for custom or modified designs.

Buy American:
 This product is assembled in the USA and meets the Buy America(n) government procurement requirements under FAR, DFARS, and DOT regulations. [Click here for additional information.](#)

WG118 LED

Weight: 17.0 lbs.
EPA: 1.1

Catalog Logic

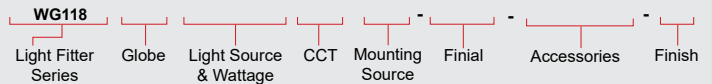

Catalog Number	1	2	3	4	5	6	7
WG118							

1	GLOBE
CL (Clear Polycarbonate)	
FR (Frosted Polycarbonate)	
WH (White Opal Polycarbonate)	

2	LIGHT SOURCE AND WATTAGES
AM10WD (10W ANP Module COB)	
AM20WD (20W ANP Module COB)	
AM30WD (30W ANP Module COB)	

3	CCT (COLOR TEMPERATURE)
27K (2700K)	
30K (3000K)	
35K (3500K)	
40K (4000K)	
*Consult Factory for 5000K and Amber	

4	MOUNTING SOURCE
S3 (Slips over Ø3" Pole or Tenon)	
OM (Other Mounting, Please Specify)	

5	OPTIONAL FINIALS
FINIAL 02 (Finial 02)	
FINIAL 04 (Finial 04)	
FINIAL 05 (Finial 05)	
FINIAL 12 (Finial 12)	
FINIAL 13 (Finial 13)	
FINIAL 32 (Finial 32)	
FINIAL 35 (Finial 35)	
FINIAL 46 (Finial 46)	
FINIAL 63 (Finial 63)	
FINIAL 113 (Finial 113)	

6	ACCESSORIES
*EMG-LED10.7 (10.7W LED Emergency Driver, See Below For Compatibility)	
*EMG-LED17 (17W LED Emergency Driver, See Below For Compatibility)	
**HLMSPC-06 (On/Off Motion Sensor/Photocell, High/Low field-configurable; 15' - 30' Sensor Mounting Height)	
**HLMSPC-10 (On/Off Motion Sensor/Photocell, High/Low field-configurable; 8' - 15' Sensor Mounting Height)	
PC (Button Photo Cell)	
**TLPC (ANSI C136.41 Twist Lock Photocell, includes receptacle and 120-277V photo cell)	
**TL5 (ANSI C136.41 5-Pin Twist Lock Receptacle only)	
**TL7 (ANSI C136.41 7-Pin Twist Lock Receptacle only)	
FAID (Field Adjustable Internal Dimmer)	
*Most Emergency Drivers are remote mount only (consult factory). 10W & 30W Emergency Drivers are not compatible with all LED Light Source and Wattages. For percent lumens in emergency mode, see Technical Section	
** Not integral to luminaire - requires additional product such as arm or pole.	

7 FINISHES						
*Premium and Marine Grade Finish have additional charges						
Standard Colors	Standard Grade	Marine Grade*	Standard Colors	Standard Grade	Marine Grade*	
Aspen Green	10	10M	Copper Clay	53	53M	
Cantaloupe	11	11M	Silver	56	56M	
Lilac	12	12M	Black Verde	61	61M	
Putty	13	13M	Painted Chrome	70	70M	
Raw Unfinished	40	NA	Painted Copper	71	71M	
Black	41	41M	Textured Black	72	72M	
Forest Green	42	42M	Matte Black	73	73M	
Bright Red	43	43M	Textured Architectural Bronze	76	76M	
White	44	44M	Textured White	77	77M	
Bright Blue	45	45M	Textured Silver	78	78M	
Sunny Yellow	46	46M	PREMIUM FINISH	Premium Grade*	Marine Grade*	
Aqua Green	47	47M	Textured Desert	80	80M	
Galvanized	49	NA	Graystone	82	82M	
Navy	50	50M	Oil Rubbed Bronze	83	83M	
Architectural Bronze	51	51M	Carbon Graphite	96	96M	
Patina Verde	52	52M				

Consult Factory for additional paint charges and availability.

Project: _____
 Fixture Type: _____ Quantity: _____
 Customer: _____

PERFORMANCE TABLE - ANP MODULE - FROSTED GLOBE - DELIVERED LUMENS

LED CATALOG	WATTS	DISTRIBUTION	2700K				3000K				3500K				4000K							
			DELIVERED LUMENS	lm/W	B	U	G	DELIVERED LUMENS	lm/W	B	U	G	DELIVERED LUMENS	lm/W	B	U	G	DELIVERED LUMENS	lm/W	B	U	G
AM10WD	10W	TYPE V	737	74	0	3	1	767	77	0	3	1	777	78	0	3	1	778	78	0	3	1
AM20WD	20W	TYPE V	1475	74	0	4	1	1533	77	0	4	1	1555	78	0	4	1	1556	78	0	4	1
AM30WD	30W	TYPE V	2212	74	1	5	2	2300	77	1	5	2	2332	78	1	5	2	2335	78	1	5	2

PERFORMANCE TABLE - ANP MODULE - WHITE GLOBE - DELIVERED LUMENS

LED CATALOG	WATTS	DISTRIBUTION	2700K				3000K				3500K				4000K							
			DELIVERED LUMENS	lm/W	B	U	G	DELIVERED LUMENS	lm/W	B	U	G	DELIVERED LUMENS	lm/W	B	U	G	DELIVERED LUMENS	lm/W	B	U	G
AM10WD	10W	TYPE V	811	81	0	3	1	843	84	0	3	1	855	86	0	3	1	856	86	0	3	1
AM20WD	20W	TYPE V	1622	81	1	4	1	1687	84	1	4	1	1710	86	1	4	1	1712	86	1	4	1
AM30WD	30W	TYPE V	2434	81	1	5	2	2530	84	1	5	2	2565	86	1	5	2	2568	86	1	5	2

GLOBE POLAR CURVES

FR Globe - Polar Curves

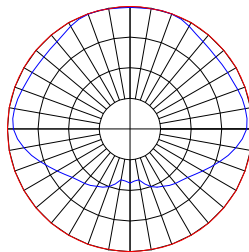

WH Globe - Polar Curves

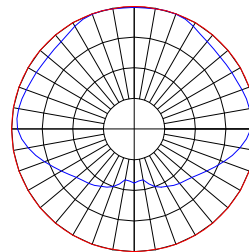

MODULE SPECIFICATION

- CREE XLAMP™ CMU
- Typical Efficacy 110 lm/W
- CCT: 2700K, 3000K, 3500K, 4000K
- CRI: >90
- 3-Step Ellipse
- Ingress Protection: IP66
- Certifications: UL Recognized, RoHS, ENEC

DRIVER SPECIFICATION

- Universal Input: 120-277V
- Dimming: 0-10V, TRIAC, ELV (Dims to 1%)
- Power Factor @ Full Load >90%
- THD @ Full Load <20%
- Constant Current Output 50/60Hz
- Operating Temperature: -30°C Minimum
- Lifetime: >50,000 hours
- Ingress Protection: IP66
- Certifications: UL Recognized, CE

FINISHES

- A polyester powder coat high quality finish is electro-statically applied and baked at 430° for exceptional durability and color retention. Products undergo an intensive five-step cleansing and pretreatment process for maximum paint adhesion. 5-year warranty for aluminum products. 2-year warranty for steel products.
- Marine grade finish provides superior salt, humidity and UV protection. This coating withstands up to 3,000 hours of continuous salt spray and is available in either a textured or gloss surface. 5-year warranty for aluminum products. 2-year warranty for steel products.

WARRANTY

See www.ANPlighting.com for complete fixture warranty.

LED warranty information

- 5 year limited warranty*
- *Limited Warranty: A typical year is defined as 4,380 hours of operation.

Project: _____
 Fixture Type: _____ Quantity: _____
 Customer: _____

ACCESSORIES



EMG-LED



HLMSPC-06 & HLMSPC-10



PC



TLPC



TL



TL5 & TL7

POPULAR POST ARMS



PA5151 / 14 1/4" x 19 3/4"



PA5171 / 15 1/4" x 25 5/8"



PA5411 / 17 7/8" x 25 1/8"



PA5621 / 19" x 26 1/4"



PA5651 / 20" x 26 1/4"



PA6211 / 22 3/4" x 26 1/2"



PA7911 / 20" x 20 5/8"



PA8031 / 20 1/2" x 20 1/4"



PA8521 / 18 1/4" x 14 1/2"



PA8571 / 24" x 47"



PA8711 / 20" x 20 3/8"



PA8831 / 18 7/8" x 18 7/8"

COLUMN MOUNT



CM / 5 3/4" SQ x 3 1/2" H

POPULAR WALL MOUNTS



WM2141 / 18" x 12 3/16"



WM2211 / 15 1/2" x 15 7/8"



WM3351 / 14 1/2" x 22"



WM4511 / 17" x 8"



WM5131 / 11" x 16 3/8"



WM5161 / 15 3/4" x 17 3/4"



WM5311 / 10 7/8" x 9 3/4"



WM5601 / 17 7/8" x 14"



WM7411 / 14" x 15 3/4"



WM8011 / 18 1/4" x 16 3/8"



WM8581 / 17 1/8" x 17 1/2"



WM8831 / 17 1/4" x 16 3/8"

Project: _____
 Fixture Type: _____ Quantity: _____
 Customer: _____

POPULAR FINIALS

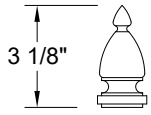

FINIAL 02

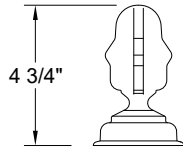

FINIAL 04

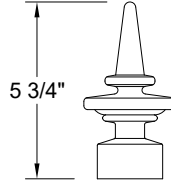

FINIAL 05

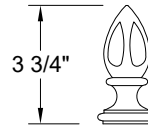

FINIAL 12

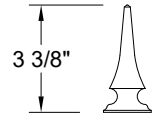

FINIAL 13

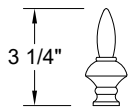

FINIAL 32

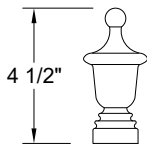

FINIAL 35

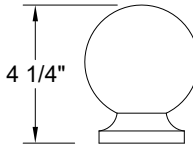

FINIAL 46

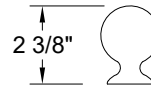

FINIAL 63

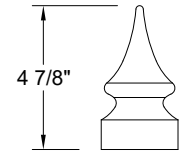

FINIAL 113

FINISHES COLORS

STANDARD

